

AS A259 flush mounted profile is applicable to all types of floors and load bearing capacity is designed for pedestrians. Dual cavity elastomeric gasket gains the profile high movement ability and can easily be changed without demounting the profile. Profile can meet horizontal & lateral shear movements. Smooth gasket design prevents the accumulation of dirt and other external factors on the profile and makes it favorable for the places where hygiene is required. It can be applied with wall profile AS 159 as matching model.

- Application Areas** : Indoor & Outdoor / Floor
- Ideal for** : Residences, Offices etc.
- Material** : Mill Finish Aluminum (Anodizing optional), TPE Gasket, Stainless Steel Spring
- Aluminum Alloy** : 6063 AA-USA / EN AW 6063
- Optional Supplies** : Fire Barrier, Waterproof EPDM membrane

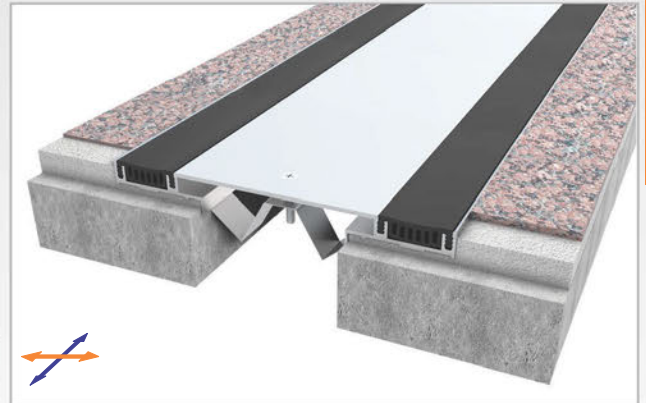

FLOOR

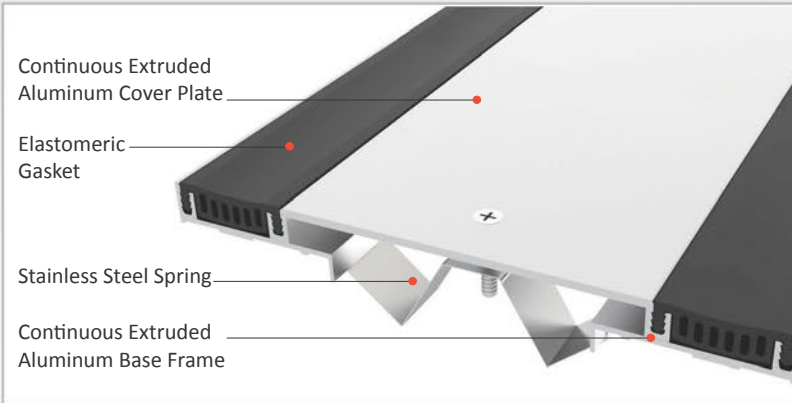
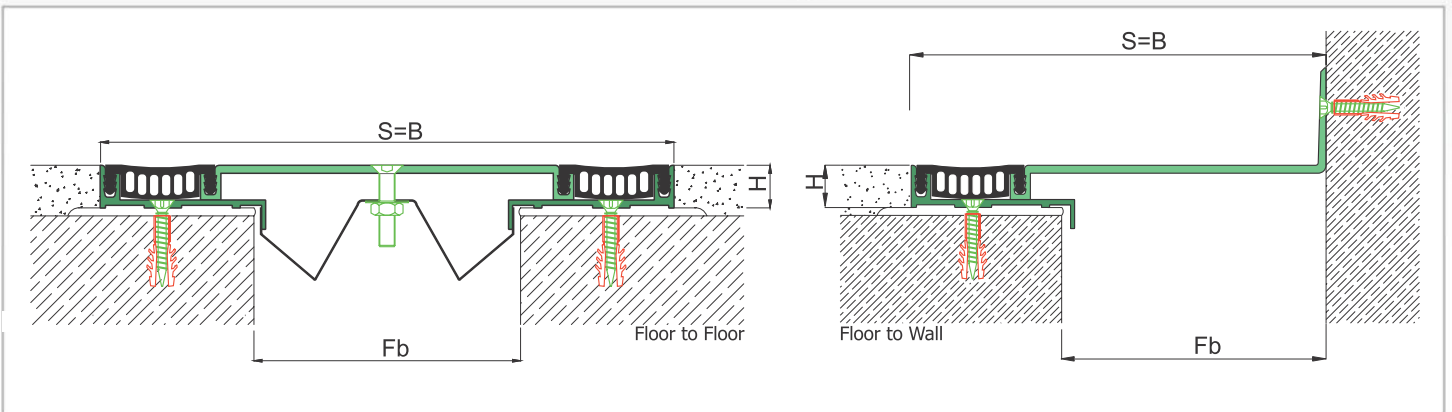

* Visuals are representative and the profile configuration may differ depending on the characteristics requested.



LOCATION	MODEL	GAP (Fb) mm	HEIGHT (H) MM	OVERALL WIDTH (B) mm	VISIBLE WIDTH (S) mm	MOVEMENT (W) mm	LOAD CAPACITY	STANDARD LENGTH (mt)
Floor to Floor	AS A259-050	50	16	165	165	± 16		3
	AS A259-100	100	16	215	215	± 16		3

Note: Please ask for different sizes

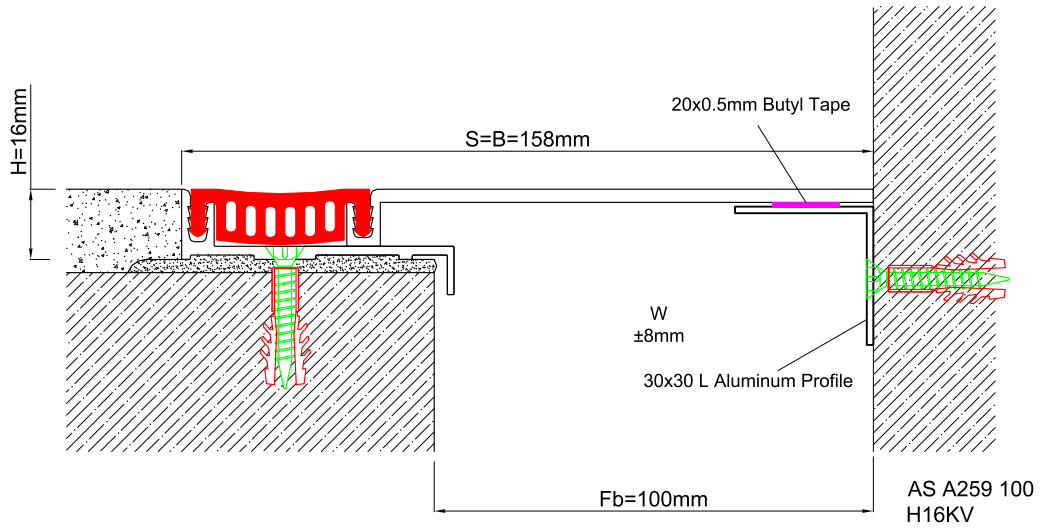
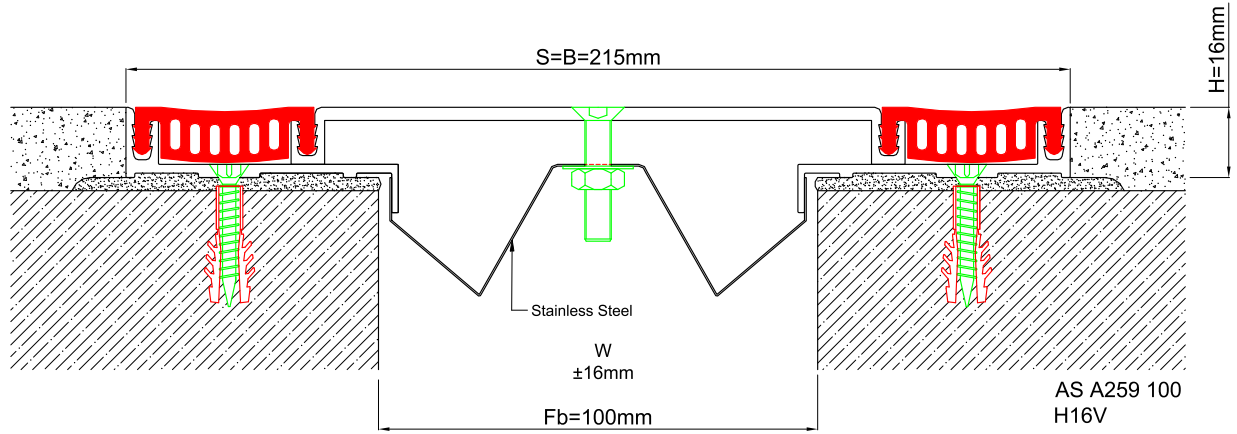

Profil No Profile Number	AS A259 100	AS A259 100K
Fb (mm)	100	100
H (mm) yaklaşık approx.	16	16
W± (mm) yaklaşık approx.	±16	±8
Renk Color	Alüminyum: Natürel, Fitiller: Siyah, gri, diğer Aluminum: Natural, Inserts: Black, grey, others	
Malzeme Material	Alüminyum, Termoplastik Kauçuk (gri ve diğer) Aluminum, Thermoplastic Rubber (grey and others)	
Standart Uzunluk Standard Length	3	
Yükleme Kapasitesi Load-Bearing Capacity	